



Model MAX10-C060

Service
Air and Pressure

Standard Specifications

Gas	Air Only
Flow Range.....	100% to 45% of Rated Flow*
Maximum Case Pressure	35 PSIG / 2.4 bar
VFD (integral)	Vacon, KEB, Yaskawa
Stages.....	Single Stage
Power Driver Options.....	Intregal Permanent Magnet Electric Motor
Cooling	Self Cooled Air Cooled
Bearings	NSTB+ Air Foil
Enclosure.....	Standard
Sound Level.....	75 dB @ 3 feet free field
Filtration Rating (std).....	99% at 2 micron, or as required

Control Options

Control Methods	Speed Control, Blow Off Control, Pressure, Flow
Local Controller.....	sLOC™ Standard - Custom for Allen Bradley, Modicon, Siemens or Other
HMI.....	sLOC™ Standard or Custom HMI
Remote Monitoring	sLINK™ or Custom
Control Set Points	Pressure, Flow, Power, Custom Input

Standard Materials of Construction

Casing.....	A356 Cast Aluminum
Volute	A356 Cast Aluminum
Bearings	Inconel with Teflon, Nano Silver Coatings
Impeller.....	5 Axis Machined anodized 7075 Aluminum
Shaft	Titanium alloy with Sm2CO17 Magnets
Blower Base Skid	ASTM A36 Structural Steel
Isolation Pads.....	Adjustable Feet with Mounting Anchor
Finish.....	Powder Coated Cabinet

Optional Testing & Certifications

Electrical.....	UL 508A, UL 1450, CSA, CE, IEEE519
Hazardous Location	Not Classified
Balancing.....	ISO 1940 - G2.5, ~4W/N API
Noise Level.....	OSHA 1910.95, ISO 2151:2004
Performance Testing	ASME PTC-10, PTC-13, ISO 5389

Standard Options

- High and Low Ambient Temperature
- Sperated Electrical and Mechanical Enclosure
- Flanged Intake
- Outdoor Enclosure
- Dual and Duplex Options
- Harmonic Filter

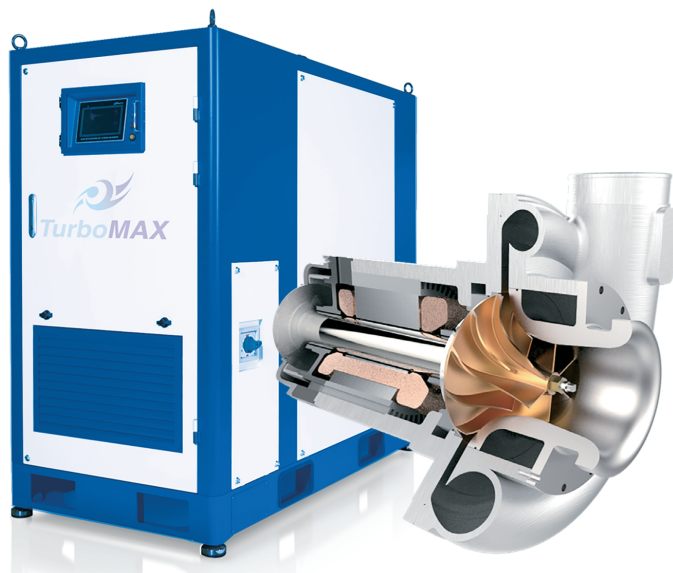
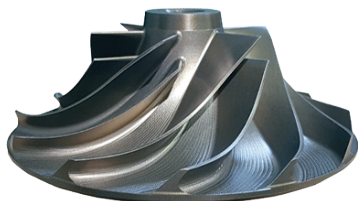
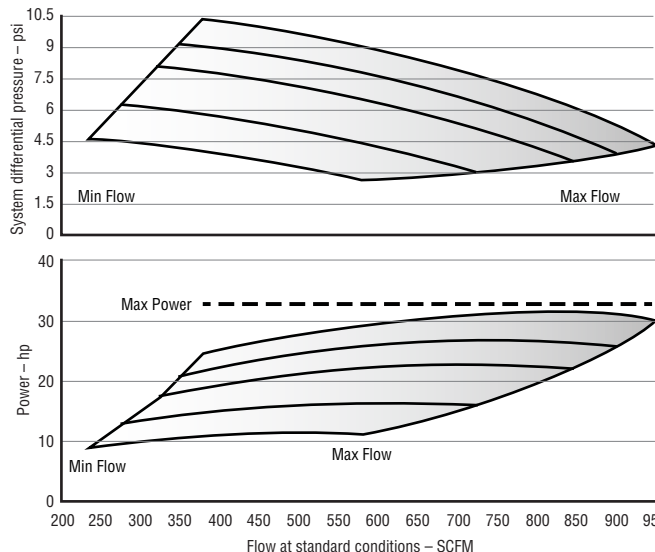

VIEW "E-E"
(LOOKING DOWNWARD)

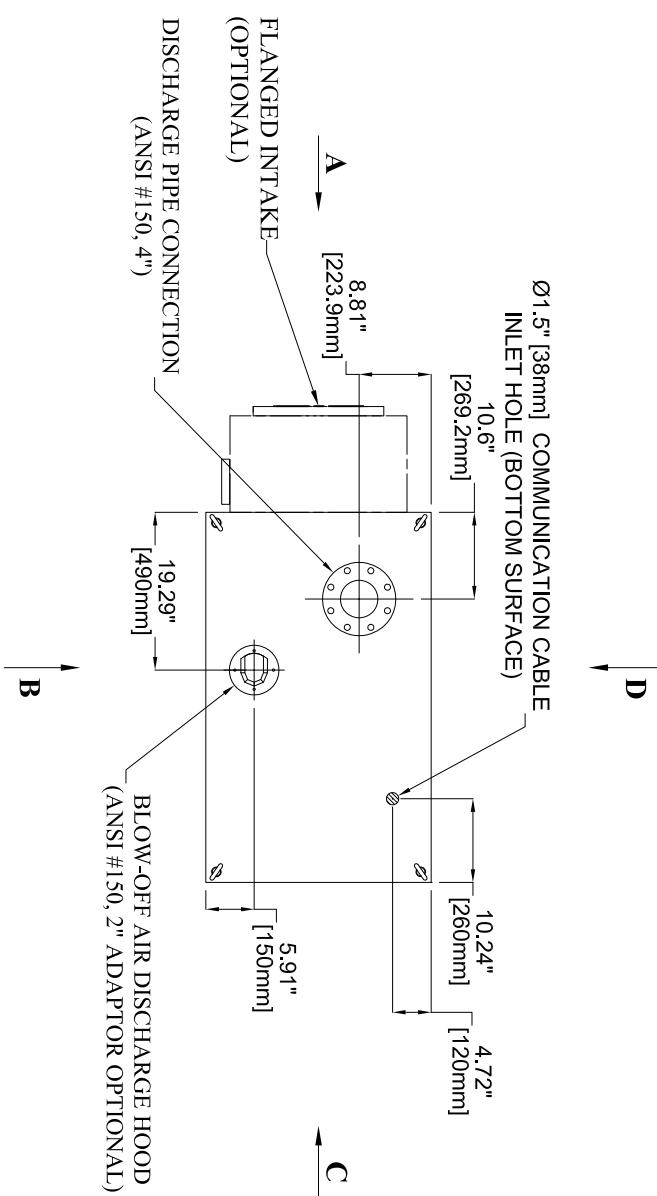

VIEW "A"
(REAR SIDE)

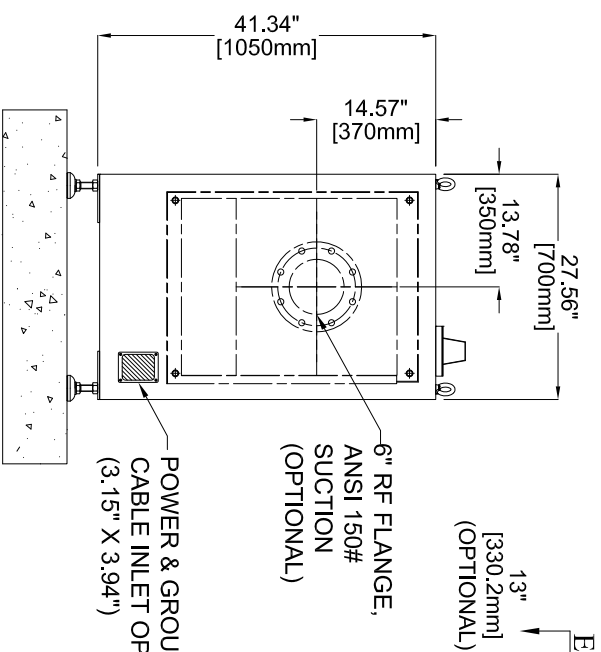

VIEW "B"
(LEFT SIDE)

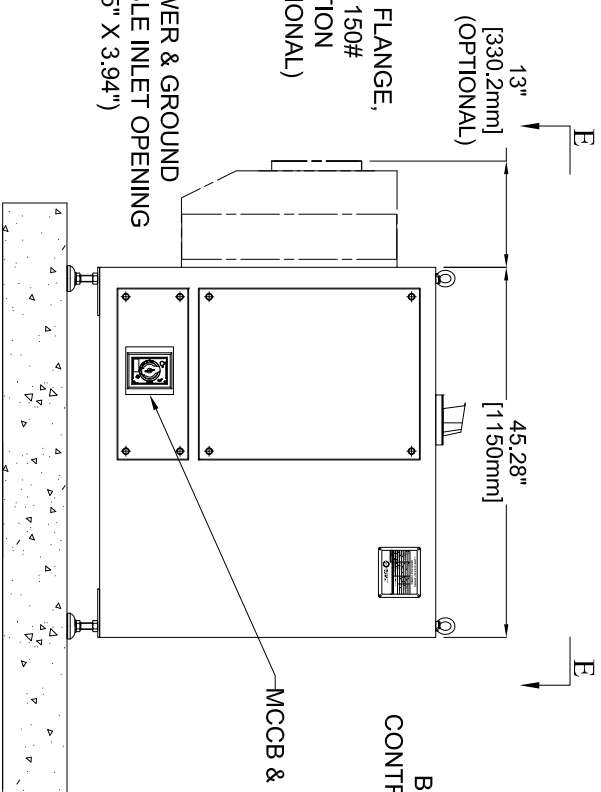

VIEW "C"
(FRONT SIDE)

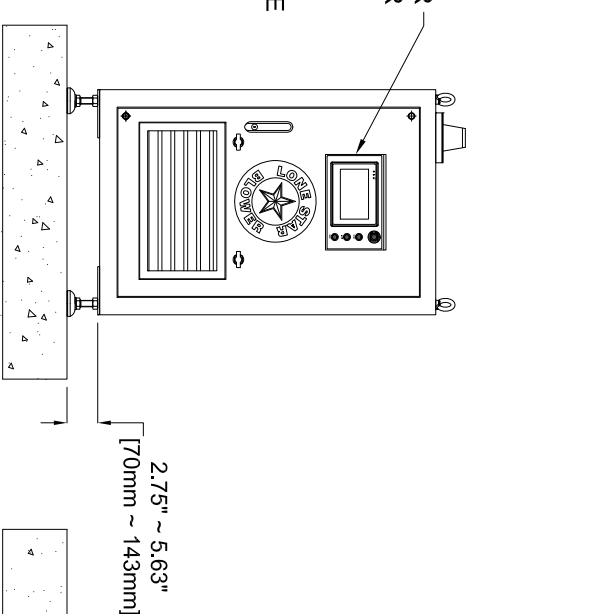

VIEW "D"
(RIGHT SIDE)

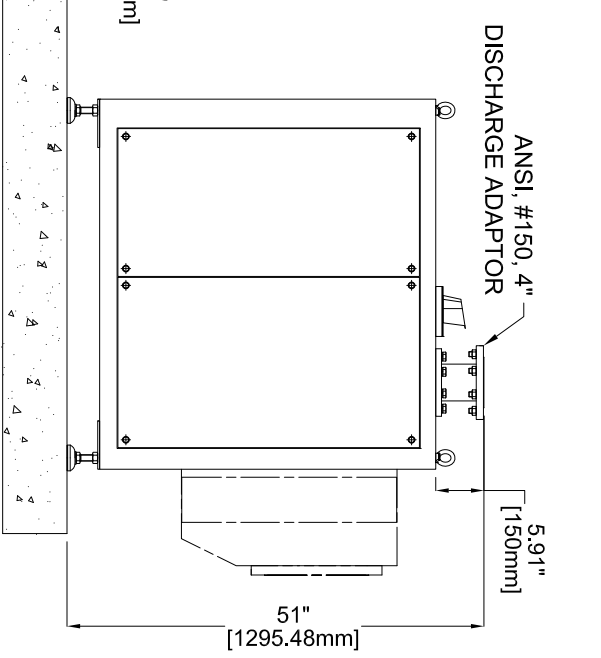

MODELS	WEIGHT
MAX10-C060 LOUVER	550 LBS (250 KG)
MAX10-C060 FLANGED INTAKE	660 LBS (300 KG)

UNLESS OTHERWISE SPECIFIED
DO NOT SCALE

LONE STAR BLOWER PROPRIETARY RIGHTS ARE INCLUDED HEREIN. THIS INFORMATION MAY NOT BE COPIED, TRANSFERRED, OR DISCLOSED, EXCEPT AS AUTHORIZED BY LONE STAR BLOWER.

DRAWING IS FOR REFERENCE ONLY
UNLESS SPECIFIED AS RELEASED.



APPROVALS		TITLE	
DRAWN	JMC	DT SERIES	
CHECK		BLOWER MAX10-C060	
ENGINEER		SIZE	SCALE
MANUFACTURING		A	A
CONTROL			
APPROVED			

REV	DESCRIPTION	DATE	APPROVED
0			

REV	DESCRIPTION	DATE	APPROVED
0			

REVISION HISTORY

THIRD ANGLE PROJECTION

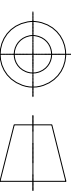

REV	DESCRIPTION	DATE	APPROVED
0			

REV	DESCRIPTION	DATE	APPROVED
0			