



Model MAX35-C060/080

Service
Air and Pressure

Standard Specifications

Gas	Air Only
Flow Range.....	100% to 45% of Rated Flow*
Maximum Case Pressure	35 PSIG / 2.4 bar
VFD (integral)	Vacon, KEB, Yaskawa
Stages.....	Single Stage
Power Driver Options.....	Intregal Permanent Magnet Electric Motor
Cooling	Self Cooled Air Cooled
Bearings	NSTB+ Air Foil
Enclosure.....	Standard
Sound Level	75 dB @ 3 feet free field
Filtration Rating (std).....	99% at 2 micron, or as required

Control Options

Control Methods	Speed Control, Blow Off Control, Pressure, Flow
Local Controller.....	sLOC™ Standard - Custom for Allen Bradley, Modicon, Siemens or Other
HMI.....	sLOC™ Standard or Custom HMI
Remote Monitoring	sLINK™ or Custom
Control Set Points	Pressure, Flow, Power, Custom Input

Standard Materials of Construction

Casing.....	A356 Cast Aluminum
Volute	A356 Cast Aluminum
Bearings	Inconel with Teflon, Nano Silver Coatings
Impeller.....	5 Axis Machined anodized 7075 Aluminum
Shaft	Titanium alloy with Sm2C017 Magnets
Blower Base Skid	ASTM A36 Structural Steel
Isolation Pads.....	Adjustable Feet with Mounting Anchor
Finish.....	Powder Coated Cabinet

Optional Testing & Certifications

Electrical.....	UL 508A, UL 1450, CSA, CE, IEEE519
Hazardous Location	Not Classified
Balancing.....	ISO 1940 - G2.5, ~4W/N API
Noise Level.....	OSHA 1910.95, ISO 2151:2004
Performance Testing	ASME PTC-10, PTC-13, ISO 5389

Standard Options

- High and Low Ambient Temperature
- Sperated Electrical and Mechanical Enclosure
- Flanged Intake
- Outdoor Enclosure
- Dual and Duplex Options
- Harmonic Filter

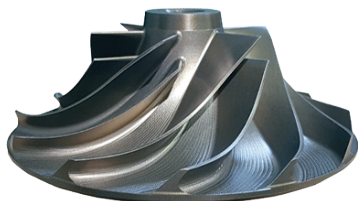
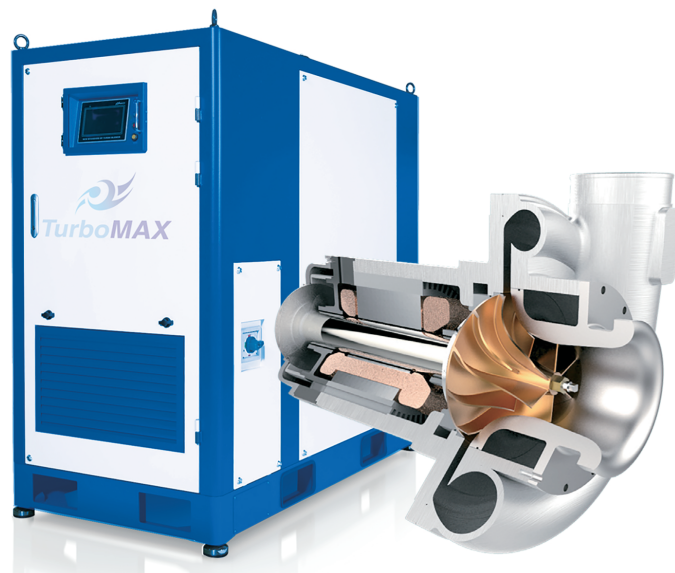

VIEW "E-E"
(LOOKING DOWNWARD)

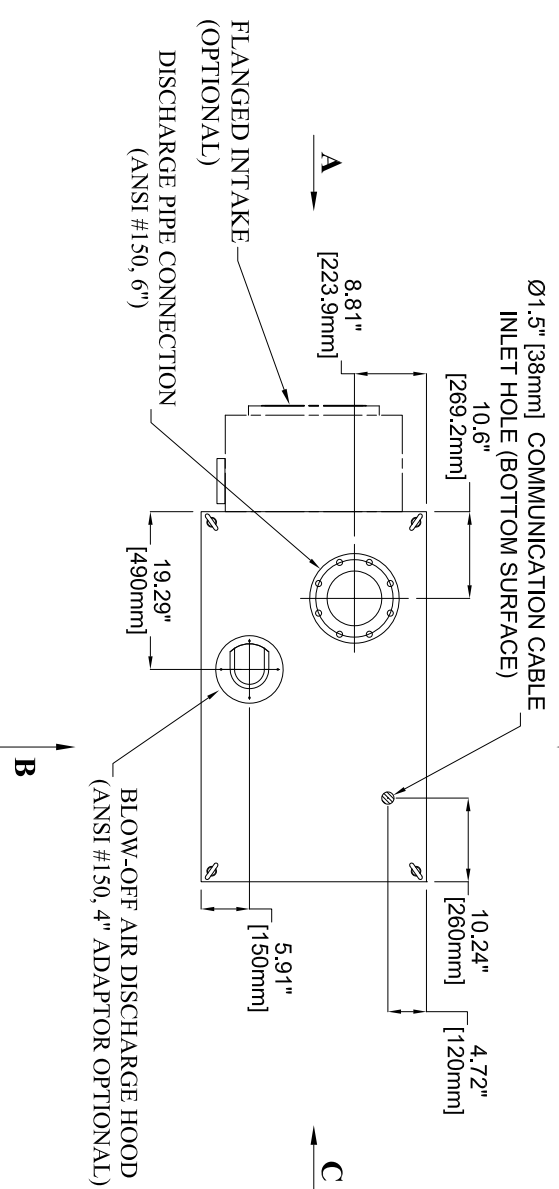

VIEW "A"
(REAR SIDE)

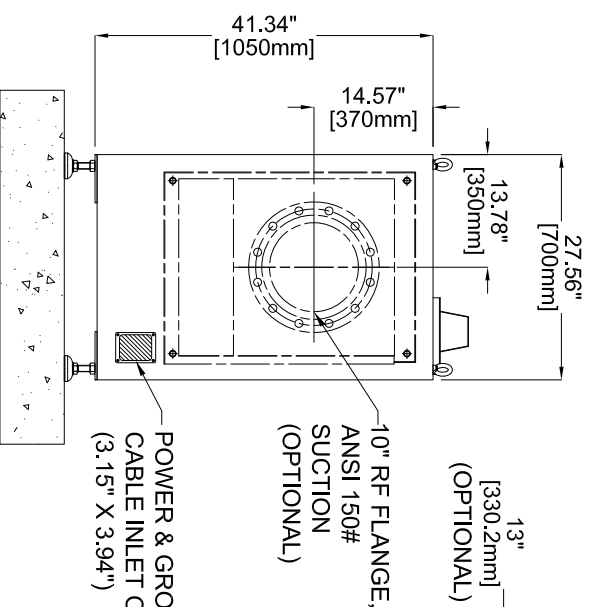

VIEW "B"
(LEFT SIDE)

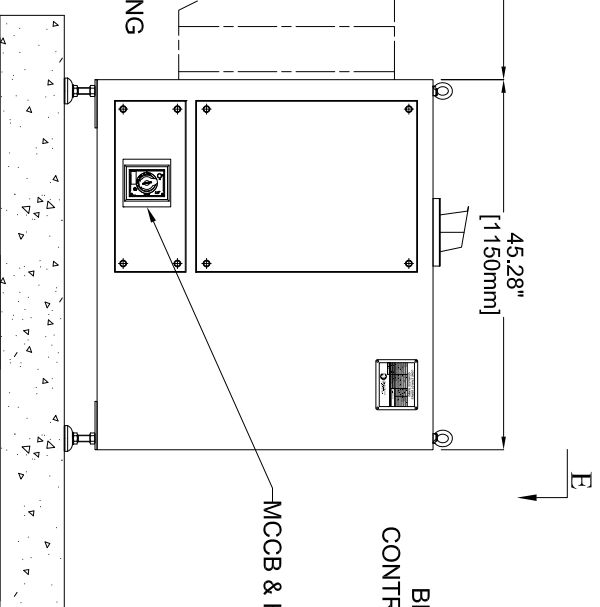

VIEW "C"
(FRONT SIDE)

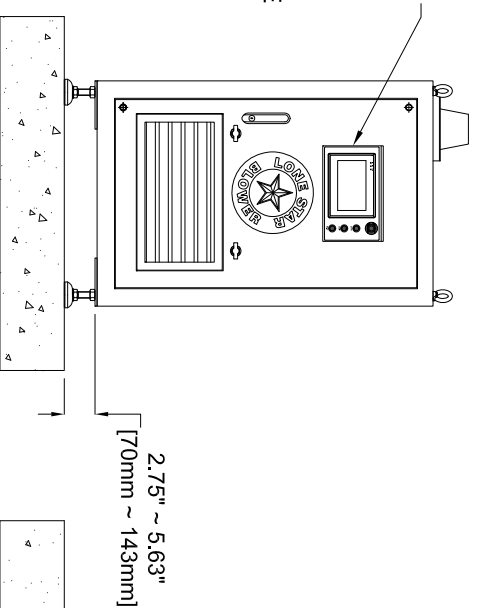

VIEW "D"
(RIGHT SIDE)

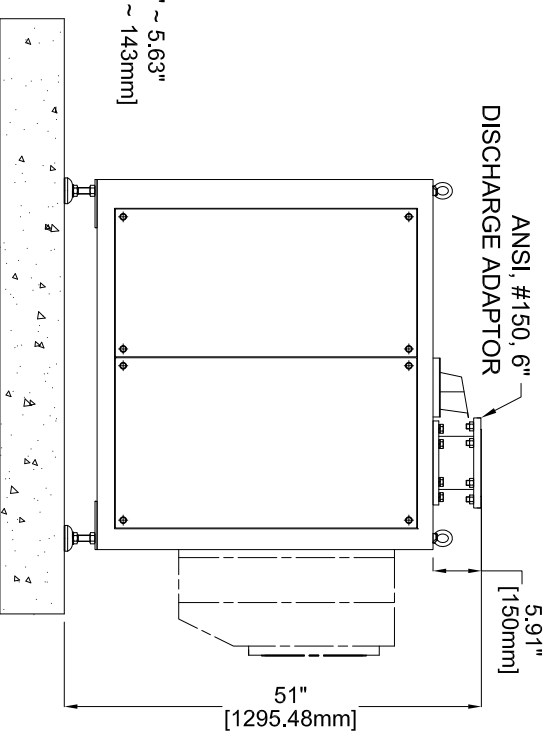

ALL DIMENSIONS ARE SUBJECT TO CHANGE WITHOUT NOTICE.
PLEASE CONSULT WITH LONE STAR PRIOR TO DESIGNING AROUND PARTICULAR EQUIPMENT.

MODELS	WEIGHT
MAX35-C060-C080 LOUVER	840 LBS (380 KG)
MAX35-C060-C080 FLANGED INTAKE	940 LBS (425 KG)

UNLESS OTHERWISE SPECIFIED
DO NOT SCALE

LONE STAR BLOWER PROPRIETARY RIGHTS ARE INCLUDED HEREIN. THIS INFORMATION MAY NOT BE COPIED, TRANSFERRED, OR DISCLOSED, EXCEPT AS AUTHORIZED BY LONE STAR BLOWER.

DRAWING IS FOR REFERENCE ONLY
UNLESS SPECIFIED AS RELEASED.



TITLE
DT SERIES

BLOWER MAX35-C060 / C080

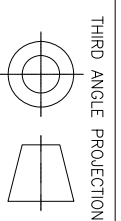

APPROVALS		APPROVALS		APPROVALS	
DRAWN	JMC	DATE	06/04/2021	TITLE	DT SERIES
CHECK		ENGINEER		MODEL	BLOWER MAX35-C060 / C080
MANUFACTURING		CONTROL		SCALE	A
APPROVED					

REVISION HISTORY		
REV	DESCRIPTION	DATE